

Owner's Manual



Fig. 1 – Sizes 09K -36K

TABLE OF CONTENTS

	PAGE
A NOTE ABOUT SAFETY.....	2
GENERAL.....	6
BEFORE INSTALLATION.....	6
INSTALLATION.....	6
FCC.....	7
WIRELESS REMOTE CONTROLLER.....	8
WIRELESS REMOTE CONTROL LCD SCREEN INDICATORS.....	9
GETTING TO KNOW YOUR AC.....	13
ADDITIONAL FEATURES.....	14
CARE AND MAINTENANCE.....	15
TROUBLESHOOTING.....	17
ERROR CODES.....	19

NOTE TO EQUIPMENT OWNER:

Please read this Owner's Information Manual carefully before installing and using this appliance and keep this manual for future reference.

For your convenience, please record the model and serial numbers of your new equipment in the spaces provided. This information, along with the installation data and dealer contact information, will be helpful should your system require maintenance or service.

UNIT INFORMATION

Model # _____

Serial # _____

DEALERSHIP CONTACT INFORMATION

Company Name: _____

Address: _____

INSTALLATION INFORMATION

Date Installed _____

Phone Number: _____

Technician Name: _____

A NOTE ABOUT SAFETY

This is the safety-alert symbol

Anytime you see this symbol in manuals, instructions, and on the unit, be aware of the potential for personal injury. There are three levels of precaution:

1. **DANGER** identifies the most serious hazards which will result in severe personal injury or death.
2. **WARNING** signifies hazards which could result in personal injury or death.
3. **CAUTION** is used to identify unsafe practices which may result in minor personal injury or product and property damage.

NOTE is used to highlight suggestions which will result in enhanced installation, reliability, or operation.



WARNING

PERSONAL INJURY AND PROPERTY DAMAGE HAZARD
 For continued performance, reliability, and safety, the only approved accessories and replacement parts are those specified by the equipment manufacturer. The use of non-manufacturer approved parts and accessories could invalidate the equipment limited warranty and result in fire risk, equipment malfunction, and failure.
 Review the manufacturer's instructions and replacement parts catalogs available from your equipment supplier.

WARNING - RISK OF FIRE DUE TO FLAMMABLE REFRIGERANT USED. FOLLOW HANDLING INSTRUCTIONS CAREFULLY IN COMPLIANCE WITH NATIONAL REGULATIONS.



NOTE: Risk of Fire. Flammable refrigerant used. To be repaired only by trained service personnel. Do not puncture refrigerant tubing.



WARNING

PERSONAL INJURY, DEATH AND / OR PROPERTY DAMAGE HAZARD
 Failure to follow this warning could result in personal injury, death or property damage.
 Improper installation, adjustment, alteration, service, maintenance, or use can cause explosion, fire, electrical shock, or other conditions which may cause personal injury or property damage. Consult a qualified installer, service agency, or your distributor or branch for information or assistance. The qualified installer or service agency must use factory-authorized kits or accessories when modifying this product.
 Read and follow all instructions and warnings, including labels shipped



WARNING





This appliance is not intended for use by persons (including children) with reduced physical, sensory or mental capabilities, or lack of experience and knowledge, unless they have been given supervision or instruction concerning use of the appliance by a person responsible for their safety. Children should be supervised to ensure that they do not play with the appliance.



WARNING

FOR FLAMMABLE REFRIGERANTS
 Do not use means to accelerate the defrosting process or to clean, other than those recommended by the manufacturer.
 The appliance shall be stored in a room without continuously operating ignition sources (for example: open flames, an operating gas appliance or an operating electric heater).
 Do not pierce or burn.
 Be aware that refrigerants may not contain an odor.

Table 1 —Symbols displayed on the indoor unit or outdoor unit

 A2L	WARNING	This symbol shows that this appliance used a flammable refrigerant. If the refrigerant is leaked and exposed to an external ignition source, there is a risk of fire.
	CAUTION	This symbol shows that the operation manual should be read carefully.
	CAUTION	This symbol shows that a service personnel should be handling this equipment with reference to the installation manual.
	CAUTION	This symbol shows that information is available such as the operating manual or installation manual.

1. **Installation** (where refrigerant pipes are allowed)

Any person who is involved with working on or breaking into a refrigerant circuit should hold a current valid certificate from an industry-accredited assessment authority, which authorizes their competence to handle refrigerants safely in accordance with an industry recognized assessment specification.

Maintenance and repair requiring the assistance of other skilled personnel shall be carried out under the supervision of the person competent in the use of flammable refrigerants.

That the installation of pipe-work shall be kept to a minimum.

That pipe-work shall be protected from physical damage.

Where refrigerant pipes shall be compliance with national gas regulations.

That mechanical connections shall be accessible for maintenance purposes.

Be more careful that foreign matter (oil, water, etc) does not enter the piping.

Also, when storing the piping, securely seal the opening by pinching, taping, etc.

All working procedure that affects safety means shall only be carried by competent persons.

Appliance shall be stored in a well ventilated area where the room size corresponds to the room area as specified for operation.

Joints shall be tested with detection equipment with a capability of 5 g/year of refrigerant or better, with the equipment in standstill and under operation or under a pressure of at least these standstill or operation conditions after installation. Detachable joints shall NOT be used in the indoor side of the unit (brazed, welded joint could be used). In cases that require mechanical ventilation, ventilation openings shall be kept clear of obstruction.

2. **When a FLAMMABLE REFRIGERANT is used**, the requirements for installation space of appliance and/or ventilation requirements are determined according to

- the mass charge amount (M) used in the appliance, the installation location, the type of ventilation of the location or of the appliance. piping material, pipe routing, and installation shall include protection from physical damage in operation and service, and be in compliance with national and local codes and standards, such as ASHRAE 15, IAPMO Uniform Mechanical Code, ICC International Mechanical Code, or CSA B52. All field joints shall be accessible for inspection prior to being covered or enclosed.

that protection devices, piping, and fittings shall be protected as far as possible against adverse environmental affects, for example, the danger of water collecting and freezing in relief pipes or the accumulation of dirt and debris;

- that piping in refrigeration systems shall be so designed and installed to minimize the likelihood of hydraulic shock damaging the system;

- that steel pipes and components shall be protected against corrosion with a rustproof coating before applying any insulation;

- that precautions shall be taken to avoid excessive vibration or pulsation;

the minimum floor area of the room shall be mentioned in the form of a table or a single figure without reference to a formula; after completion of field piping for split systems, the field pipework shall be pressure tested with an inert gas and then vacuum tested prior to refrigerant charging, according to the following requirements:

- a. The minimum test pressure for the low side of the system shall be the low side design pressure and the minimum test pressure for the high side of the system shall be the high side design pressure, unless the high side of the system cannot be isolated from the low side of the system in which case the entire system shall be pressure tested to the low side design pressure.

- b. The test pressure after removal of pressure source shall be maintained for at least 1 h with no decrease of pressure indicated by the test gauge, with test gauge resolution not exceeding 5% of the test pressure.

- c. During the evacuation test, after achieving a vacuum level specified in the manual or less, the refrigeration system shall be isolated from the vacuum pump and the pressure shall not rise above 1500 microns within 10 min. The vacuum pressure level shall be specified in the manual, and shall be the lessor of 500 microns or the value required for compliance with national and local codes and standards, which may vary between residential, commercial, and industrial buildings.

- field-made refrigerant joints indoors shall be tightness tested according to the following requirements: The test method shall have a sensitivity of 5 grams per year of refrigerant or better under a pressure of at least 0.25 times the maximum allowable pressure. No leak shall be detected.

3. **Qualification of Workers**

Any maintenance, service and repair operations must be required qualification of the working personnel. Every working procedure that affects safety means shall only be carried out by competent persons that joined the training and achieved competence should be documented by a certificate. The training of these procedures is carried out by national training organizations or manufacturers that are accredited to teach the relevant national competency standards that may be set in legislation. All training shall follow the ANNEX HH requirements of UL 60335-2-40 4th Edition.

Examples for such working procedures are:

- breaking into the refrigerating circuit;
- opening of sealed components;
- opening of ventilated enclosures.

Information Servicing

1. **Checks to the area**

Prior to beginning work on systems containing flammable refrigerants, safety checks are necessary to ensure that the risk of ignition is minimized. For repair to the refrigerating system, the following precautions shall be complied with prior to conducting work on the system.

2. **Work procedure**

Works shall be undertaken under a controlled procedure so as to minimize the risk of a flammable gas or vapor being present while the work is being performed.

3. **General work area**

All maintenance staff and others working in the local area shall be instructed on the nature of work being carried out. work in confined spaces shall be avoided.

4. **Checking for presence of refrigerant**

The area shall be checked with an appropriate refrigerant detector prior to and during work, to ensure the technician is aware of potentially flammable atmospheres. Ensure that the leak detection equipment being used is suitable for use with flammable refrigerants, i.e. no sparking, adequately sealed or intrinsically safe.

5. **Presence of a fire extinguisher**

If any hot work is to be conducted on the refrigeration equipment or any associated parts, appropriate fire extinguishing equipment shall be available to hand. Have a dry power or CO2 fire extinguisher adjacent to the charging area.

6. No ignition sources

No person carrying out work in relation to a REFRIGERATING SYSTEM which involves exposing any pipe work shall use any sources of ignition in such a manner that it may lead to the risk of fire or explosion. All possible ignition sources, including cigarette smoking, should be kept sufficiently far away from the site of installation, repairing, removing and disposal, during which refrigerant can possibly be released to the surrounding space. Prior to work taking place, the area around the equipment is to be surveyed to make sure that there are no flammable hazards or ignition risks. "No Smoking" signs shall be displayed.

7. Ventilated area

Ensure that the area is in the open or that it adequately ventilated before breaking into the system or conducting any hot work. A degree of ventilation shall continue during the period that the work is carried out. The ventilation should safely disperse any released refrigerant and preferably expel it externally into the atmosphere.

8. Checks to the refrigeration equipment

Where electrical components are being changed, they shall be fit for the purpose and to the correct specification. At all times the manufacturer's maintenance and service guidelines shall be followed. If in doubt consult the manufacturer's technical department for assistance. The following checks shall be applied to installations using FLAMMABLE REFRIGERANTS:

- the actual refrigerant charge is in accordance with the room size within which the refrigerant containing parts are installed;
- the ventilation machinery and outlets are operating adequately and are not obstructed;
- if an indirect refrigerating circuit is being used, the secondary circuits shall be checked for the presence of refrigerant;
- marking to the equipment continues to be visible and legible, marking and signs that are illegible shall be corrected;
- refrigeration pipe or components are installed in a position where they are unlikely to be exposed to any substance which may corrode refrigerant containing components, unless the components are constructed of materials which are inherently resistant to being corroded or are suitably protected against being so corroded.

9. Checks to electrical devices

Repair and maintenance to electrical components shall include initial safety checks and component inspection procedures. If a fault exists that could compromise safety, then no electrical supply shall be connected to the circuit until it is satisfactorily dealt with. If the fault cannot be corrected immediately but it is necessary to continue operation, and adequate temporary solution shall be used. This shall be reported to the owner of the equipment so all parties are advised.

Initial safety checks shall include:

- that capacitors are discharged: this shall be done in a safe manner to avoid possibility of sparking
- that there no live electrical components and wiring are exposed while charging,
- recovering or purging the system; that there is continuity of earth bonding.

10. Sealed electrical components shall be replaced

11. Intrinsically safe components must be replaced.

12. Cabling

Check that cabling will not be subject to wear, corrosion, excessive pressure, vibration, sharp edges or any other adverse environmental effects. The check shall also take into account the effects of aging or continual vibration from sources such as compressors or fans.

13. Detection of flammable refrigerants

Under no circumstances shall potential sources of ignition be used in the searching for or detection of refrigerant leaks. A halide torch (or any other detector using a naked flame) shall not be used.

The following leak detection methods are deemed acceptable for refrigerant systems. Electronic leak detectors may be used to detect refrigerant leaks but, in the case of FLAMMABLE REFRIGERANTS, the sensitivity may not be adequate, or may need re-calibration. (Detection equipment shall be calibrated in a refrigerant-free area.) Ensure that the detector is not a potential source of ignition and is suitable for the refrigerant used. Leak detection equipment shall be set at a percentage of the LFL of the refrigerant and shall be calibrated to the refrigerant employed, and the appropriate percentage of gas (25% maximum) is confirmed.

Leak detection fluids are also suitable for use with most refrigerants but the use of detergents containing chlorine shall be avoided as the chlorine may react with the refrigerant and corrode the copper pipe-work.

NOTE Examples of leak detection fluids are:

- bubble method,
- fluorescent method agents.

If a leak is suspected, all naked flames shall be removed/extinguished. If a leakage of refrigerant is found which requires brazing, all of the refrigerant shall be recovered from the system, or isolated (by means of shut o valves) in a part of the system remote from the leak. See the following instructions of removal of refrigerant.

14. Removal and evacuation

When breaking into the refrigerant circuit to make repairs - or for any other purpose conventional procedures shall be used. However, for flammable refrigerants it is important that best practice be followed, since flammability is a consideration.

The following procedure shall be adhered to:

- safely remove refrigerant following local and national regulations;
- evacuate;
- purge the circuit with inert gas (optional for A2L);
- evacuate (optional for A2L);
- continuously flush or purge with inert gas when using flame to open circuit; and
- open the circuit

The refrigerant charge shall be recovered into the correct recovery cylinders if venting is not allowed by local and national codes. For appliances containing flammable refrigerants, the system shall be purged with oxygen-free nitrogen to render the appliance safe for flammable refrigerants. This process might need to be repeated several times. Compressed air or oxygen shall not be used for purging refrigerant systems.

For appliances containing flammable refrigerants, refrigerants purging shall be achieved by breaking the vacuum in the system with oxygen-free nitrogen and continuing to fill until the working pressure is achieved, then venting to atmosphere, and finally pulling down to a vacuum (optional for A2L). This process shall be repeated until no refrigerant is within the system (optional for A2L). When the final oxygen-free nitrogen charge is used, the system shall be vented down to atmospheric pressure to enable work to take place. The outlet for the vacuum pump shall not be close to any potential ignition sources, and ventilation shall be available.

15. Charging procedures

In addition to conventional charging procedures, the following requirements shall be followed:

- Works shall be undertaken with appropriate tools only (In case of uncertainty, please consult the manufacturer of the tools for use with flammable refrigerants)

- Ensure that contamination of different refrigerants does not occur when using charging equipment. Hoses or lines shall be as short as possible to minimize the amount of refrigerant contained in them.
- Cylinders shall be kept upright.
- Ensure that the refrigeration system is earthed prior to charging the system with refrigerant.
- Label the system when charging is complete (if not already).
- Extreme care shall be taken not to overfill the refrigeration system.
- Prior to recharging the system it shall be pressure tested with oxygen free nitrogen (OFN). The system shall be leak tested on completion of charging but prior to commissioning. A follow up leak test shall be carried out prior to leaving the site.

16. Decommissioning

Before carrying out this procedure, it is essential that the technician is completely familiar with the equipment and all its detail. It is recommended good practice that all refrigerants are recovered safely. Prior to the task being carried out, an oil and refrigerant sample shall be taken in case analysis is required prior to re-use of recovered refrigerant. It is essential that electrical power is available before the task is commenced.

- a. Become familiar with the equipment and its operation.
- b. Isolate system electrically
- c. Before attempting the procedure ensure that:
 - mechanical handling equipment is available, if required, for handling refrigerant cylinders;
 - all personal protective equipment is available and being used correctly;
 - the recovery process is supervised at all times by a competent person;
 - recovery equipment and cylinders conform to the appropriate standards.
- d. Pump down refrigerant system, if possible.
- e. If a vacuum is not possible, make a manifold so that refrigerant can be removed from various parts of the system.
- f. Ensure the cylinder is situated on the scales before recovery takes place.
- g. Start the recovery machine and operate in accordance with instructions.
- h. Do not overfill cylinders (no more than 80% volume liquid charge)
- i. Do not exceed the maximum working pressure of the cylinder, even temporarily.
- j. When the cylinders have been filled correctly and the process completed, make sure that the cylinders and the equipment are removed from site promptly and all isolation valves on the equipment are closed off.
- k. Recovered refrigerant shall not be charged into another refrigeration system unless it has been cleaned and checked.

17. Labeling

Equipment shall be labeled stating that it has been de-commissioned and emptied of refrigerant. The label shall be dated and signed. For appliances containing FLAMMABLE REFRIGERANTS, ensure that there are labels on the equipment stating the equipment contains FLAMMABLE REFRIGERANT.

18. Recovery

When removing refrigerant from a system, either for servicing or decommissioning, it is recommended good practice that all refrigerants are removed safely. When transferring refrigerant into cylinders, ensure that only appropriate refrigerant recovery cylinders are employed. Ensure that the correct number of cylinders for holding the total system charge is available. All cylinders to be used are designated for the recovered refrigerant and labeled for that refrigerant (i. e. special cylinders for the recovery of refrigerant). Cylinders shall be complete with pressure-relief valve and associated shut-o valves in good working order. Empty recovery cylinders are evacuated and, if possible, cooled before recovery occurs. The recovery equipment shall be in good working order with a set of instructions concerning the equipment that is at hand and shall be suitable for the recovery of the flammable refrigerant. If in doubt, the manufacturer should be consulted. In addition, a set of calibrated weighing scales shall be available and in good working order. Hoses shall be complete with leak-free disconnect couplings and in good condition.

The recovered refrigerant shall be processed according to local legislation in the correct recovery cylinder, and the relevant waste transfer note arranged. Do not mix refrigerants in recovery units and especially not in cylinders. If compressors or compressor oils are to be removed, ensure that they have been evacuated to an acceptable level to make certain that flammable refrigerant does not remain within the lubricant. The compressor body shall not be heated by an open flame or other ignition sources to accelerate this process. When oil is drained from a system, it shall be carried out safely.

19. Transportation, marking and storage for units

- a. Transport of equipment containing flammable refrigerants
Compliance with the transport regulations.
- b. Marking of equipment using signs / Compliance with local regulations.
- c. Disposal of equipment using flammable refrigerants / Compliance with national regulations.
- d. Storage of equipment/appliances / The storage of equipment should be in accordance with the manufacturer's instructions.
- e. Storage of packed (unsold) equipment / Storage package protection should be constructed such that mechanical damage to the equipment inside the package will not cause a leak of the refrigerant charge.
- f. The maximum number of pieces of equipment permitted to be stored together will be determined by local regulations.

GENERAL

The indoor unit provides quiet, maximum comfort. In addition to cooling and/or heating, the indoor unit matched with an outdoor condensing unit filters and dehumidifies the air in the room to provide maximum comfort.

IMPORTANT: The indoor unit should be installed by authorized personnel only; using approved tubing and accessories. If technical assistance, service or repair is needed, contact the installer. The indoor unit can be set up and operated from the remote control (provided). If the remote is misplaced, the system can be operated from the "Auto" setting on the unit.

Operating Modes

The indoor unit has five operating modes:

- FAN (Only)
- AUTO
- HEAT (heat pumps only)
- COOL
- DRY (Dehumidification)

FAN (Only)

In the FAN Only mode, the system filters and circulates the room air without changing room air temperature.

AUTO

In the AUTO mode, the system automatically cools or heats the room according to the user-selected set point.

NOTE: AUTO mode is recommended for use on single zone applications ONLY. Using AUTO CHANGEOVER on multizone applications could set an indoor unit to STANDBY mode, indicated with two dashes (--) on the display, which turns off the indoor unit until all the indoor units are in the same mode (COOL or HEAT). HEAT is the system's priority mode. Simultaneous heating and cooling is not allowed.

HEAT (Heat Pump models only)

In the HEAT mode, the system heats and filters the room air.

COOL

In the COOL mode, the system cools, dries and filters the room air.

DRY (Dehumidification)

In the DRY mode, the system dries, filters and slightly cools the room air temperature. This mode prioritizes air dehumidification but it does not take the place of a dehumidifier.

Wireless Remote Control

The remote control transmits commands to set up and operate the system.

The control has a window display panel that displays the current system status. The control can be secured to a surface when used with the mounting bracket provided.

Wired Remote Control (Optional)

Refer to the Wired Controller manual.

24V Interface (Optional)

Allows the control of the Ductless System with a third party thermostat.

BEFORE INSTALLATION

Pairing

The machine you purchased may be one of the types in the table below. The indoor and outdoor units are designed to be used together. Please check the machine you purchased.

NOTE: This indoor can also be paired with Mutizone units.

MODEL	INDOOR UNIT	OUTDOOR UNIT
9K (115V)	45MHHAQ09XC1	37MHRAQ09AA1
12K (115V)	45MHHAQ12XC1	37MHRAQ12AA1
9K	45MHHAQ09XC3	37MHRAQ09AA3
12K	45MHHAQ12XC3	37MHRAQ12AA3
18K	45MHHAQ18XC3	37MHRAQ18AA3
24K	45MHHAQ24XC3	37MHRAQ24AA3
30K	45MHHAQ30XC3	37MHRAQ30AA3
36K	45MHHAQ36XC3	37MHRAQ36AA3

Unit Placement

The indoor unit should be installed at least 6.0ft /1.8m above from the floor, the height of the room cannot be less than 7.3ft /2.2m, and the minimum room area of operating or storage should be as specified in the Amin table.

Refer to the Installation Manual for more details.

INSTALLATION

Any installation, maintenance, service, or repair operations must only be performed by a qualified, certified profession technician. Refer to the Installation Manual for more details.

FCC

This device complies with part 15 of the FCC Rules. Operation is subject to the following two conditions: (1) This device may not cause harmful interference, and (2) this device must accept any interference received, including interference that may cause undesired operation.

For Class B Digital Device

NOTE: This equipment has been tested and found to comply with the limits for a Class B digital device, pursuant to part 15 of the FCC Rules. These limits are designed to provide reasonable protection against harmful interference in a residential installation. This equipment generates, uses and can radiate radio frequency energy and, if not installed and used in accordance with the instructions may cause harmful interference to radio communications. However, there is no guarantee that interference will not occur in a particular installation. If this equipment does cause harmful interference to radio or television reception, which can be determined by turning the equipment off and on, the user is encouraged to try to correct the interference by one or more of the following measures:

- Reorient or relocate the receiving antenna
- Increase the distance between the equipment and the receiver
- Connect the equipment into an outlet on a circuit different from that to which the receiver is connected.
- Consult the dealer or an experienced radio/TV technician for assistance.

MODIFICATION: Any changes or modifications not expressly approved by the grantee of this device could void the user's authority to operate this device.

WIRELESS REMOTE CONTROLLER

Before you begin using your new air conditioner, familiarize yourself with the remote control.

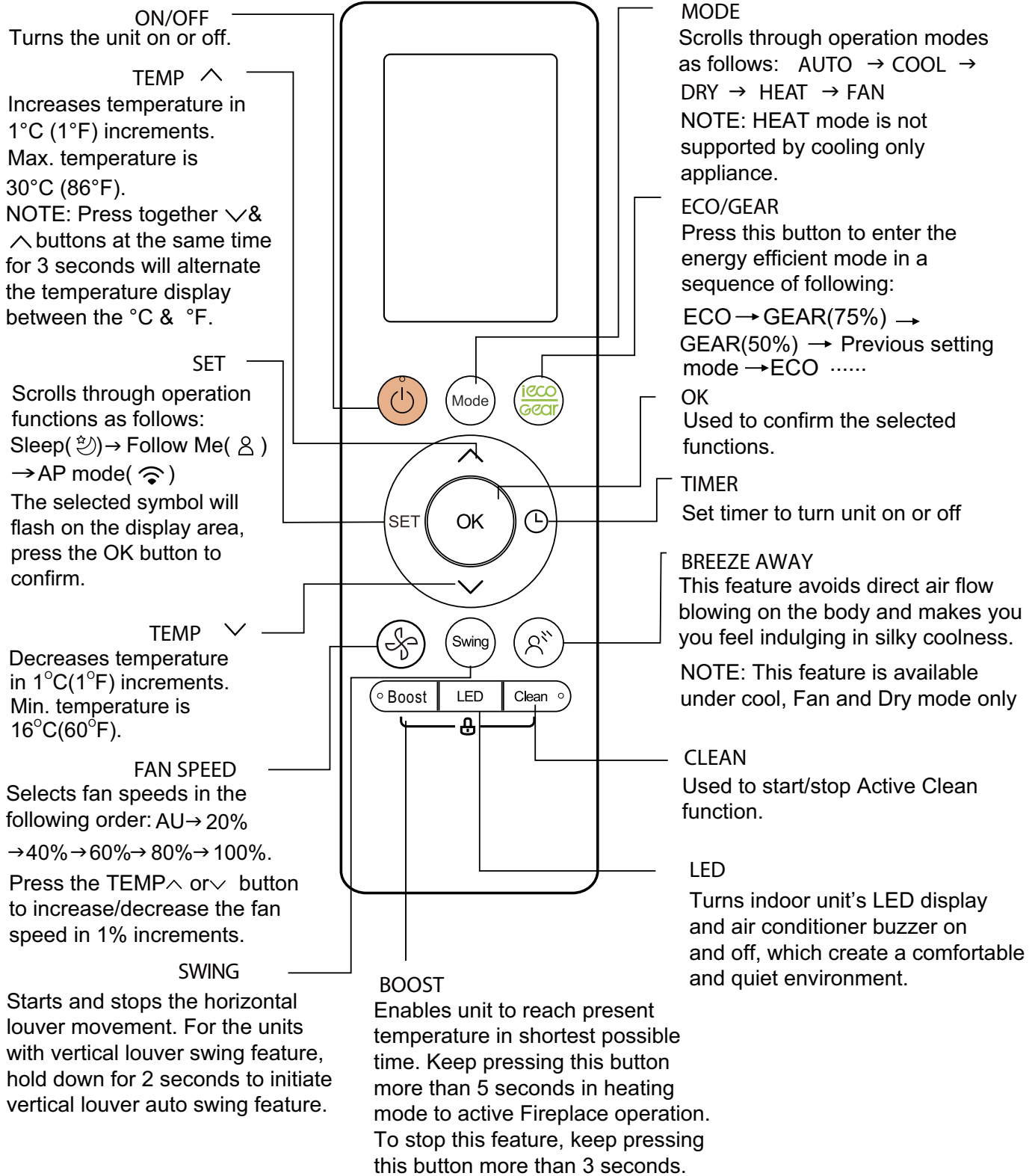









Fig. 2 —Remote Control Functions

WIRELESS REMOTE CONTROL LCD SCREEN INDICATORS

Information is displayed when the remote controller is powered up.







-  Not applicable for this unit
-  Active clean feature display
-  Breeze Away display
-  Not applicable for this unit
-  Not applicable for this unit
-  Sleep mode display
-  Not applicable for this unit
-  Follow me feature display
-  Not applicable for this unit
-  Wireless control feature display
-  Low battery detection display (If flashes)

Transmission Indicator
Lights up when remote sends signal to indoor unit

-  **TIMER ON** display
-  **TIMER OFF** display

 **Silence feature** display

FAN SPEED display

- Displays selected fan speed:
- | | | |
|---------|---|----------|
| Silence |  | 1% |
| |  | 2%-20% |
| LOW |  | 21%-40% |
| MED |  | 41%-60% |
| HIGH |  | 61%-80% |
| |  | 81%-100% |
| AUTO |  <u>AUTO</u> | |

This fan speed can not be adjusted in AUTO or DRY mode.

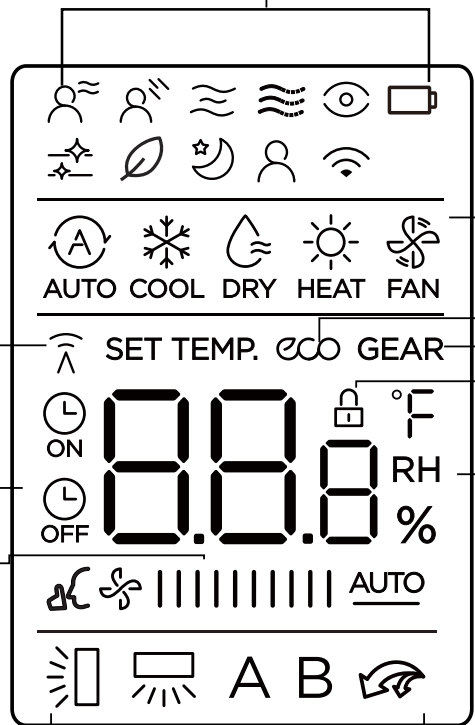

MODE display
Displays the current mode, including:

-  AUTO
-  COOL
-  DRY
-  HEAT
-  FAN

ECO display
Displays when ECO feature is activated

GEAR display
Displays when GEAR feature is activated

LOCK display
Displays when LOCK feature is activated.

Temperature/Timer/Fan speed display
Displays the set temperature by default, or fan speed or timer setting when using TIMER ON/OFF functions.

- Temperature range: 16-30°C/60-86°F
- Timer setting range: 0-24 hours
- Fan speed setting range: AU -100%

This display is blank when operating in FAN mode.

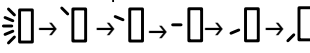
 **Horizontal louver swing** display

 **Vertical louver auto swing** display

 **Boost mode** display

A Not applicable for this unit
B Not applicable for this unit

Fig. 3 —Wireless Remote Controller Indicators

Remote Controller

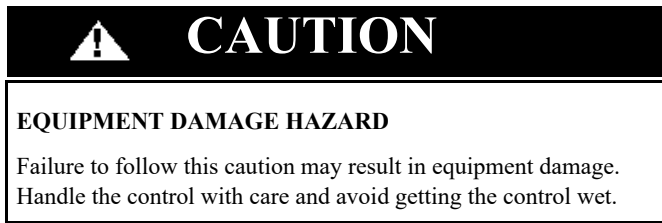

IMPORTANT: The remote control can operate the unit from a distance of up to 26 ft. (8 m) as long as there are no obstructions. When the timer function is used, the remote control should be kept in the vicinity of the fan coil (within 26 ft. / 8 m).

The remote control can perform the following basic functions:

- Turn the system ON and OFF
- Select the operating mode
- Adjust room air temperature set point and fan speed
- Adjust right-left airflow direction

Refer to the ““ADDITIONAL FEATURES” on page 14” for a detailed description of all the capabilities of the remote control. Refer to the Wireless Remote Control manual (RG10F8).

Battery Installation

Two AAA 1.5v alkaline batteries (included) are required for remote control operation.

To install or replace batteries:

1. Slide the back cover off the control to open the battery compartment.
2. Insert the batteries. Follow the polarity markings inside the battery compartment.
3. Replace the battery compartment cover.

NOTES:

1. When replacing batteries, do not use old batteries or a different type battery. This may cause the remote control to malfunction.
2. If the remote is not going to be used for several weeks, remove the batteries. Otherwise, battery leakage may damage the remote control.
3. The average battery life under normal use is about 6 months.
4. Replace the batteries when there is no audible beep from the indoor unit or if the Transmission Indicator fails to light.

When batteries are removed, the remote control erases all programmed settings. The control must be reprogrammed after the insertion of new batteries.

Basic Remote Control Operation

Before operation, ensure the unit is plugged in and power is available.

COOL Mode

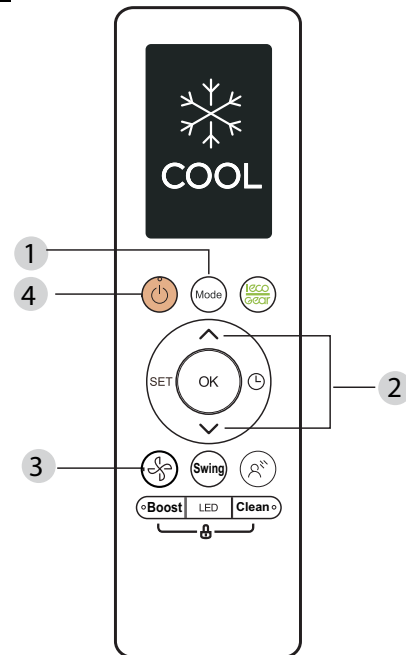

Fig. 4 —COOL Mode

1. Press MODE to select the COOL mode.
2. Set your desired temperature using the UP or DOWN arrows.
3. Press FAN to select the fan speed in a range of AU*100%.
4. Press ON/OFF to start the unit.

Setting Temperature

The operating temperature range for units is 60-86°F (16-30°C) / 68-82°F (20-28°C) (depends on model). You can increase or decrease the set temperature in 1°F (0.5°C) increments.

HEAT Mode

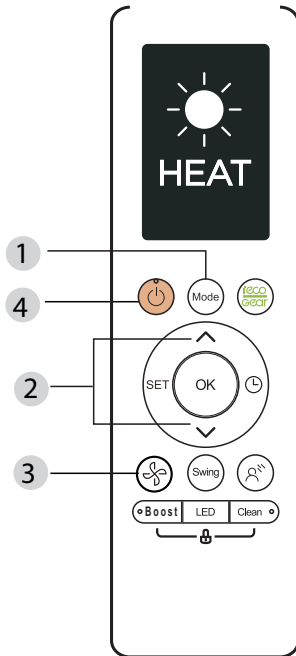

Fig. 5 —HEAT Mode

1. Press MODE to select the HEAT mode.
2. Set your desired temperature using the UP or DOWN arrows.
3. Press FAN to select the fan speed in the range of AU-100%.

NOTE: As the outdoor temperature drops, the performance of your unit's HEAT function may be affected. In such instances, we recommend using this air conditioner in conjunction with other heating appliances.

AUTO Mode

In AUTO mode, the unit automatically selects the COOL, FAN, or HEAT operation based on the set temperature.

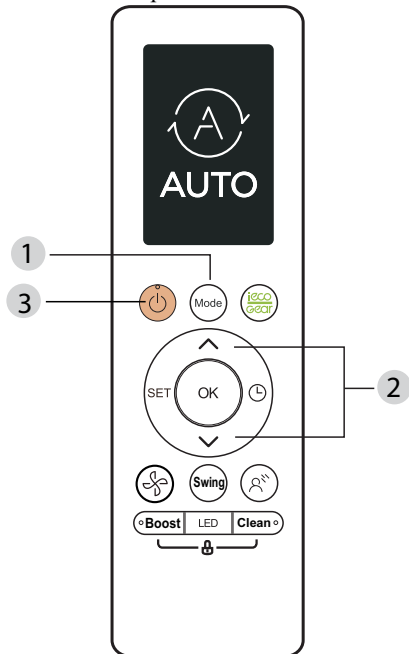

Fig. 6 —AUTO Mode

1. Press MODE to select AUTO.
2. Set your desired temperature using the UP or DOWN arrows.
3. Press ON/OFF to start the unit.

NOTE: FAN Speed can not be set in the AUTO mode.

DRY Mode

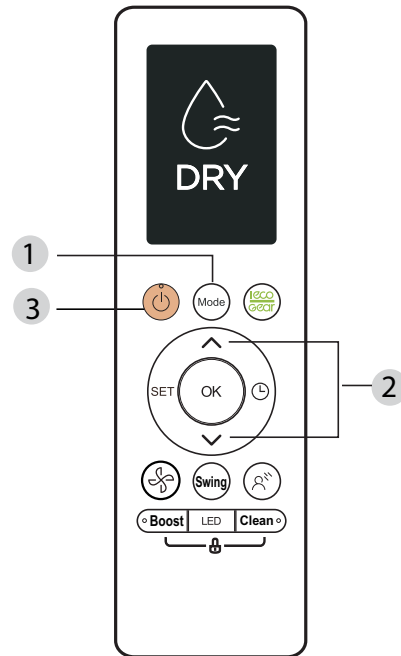

Fig. 7 —DRY Mode

1. Press MODE to select the DRY mode.
2. Set your desired temperature using the UP or DOWN arrows.
3. Press ON/OFF to start the unit.

FAN Mode

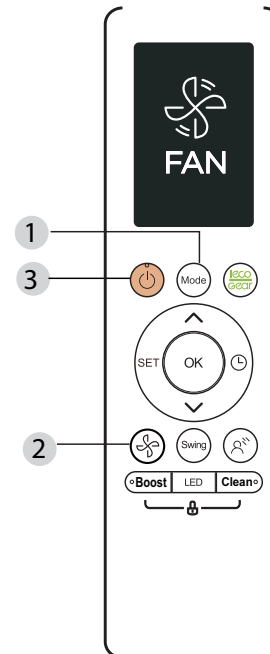

Fig. 8 —FAN Mode

1. Press MODE to select the FAN mode.
2. Press FAN to select the fan speed in the range of AU-100%.
3. Press ON/OFF to start the unit.

Remote Control Operation - Quick Start

NOTE: When transmitting a command from the remote control to the unit, be sure to point the control toward the right side of the unit. The unit confirms receipt of a command by sounding an audible beep.

1. Turn the unit on by pushing ON/OFF.

NOTE: If there is a preference for °C rather than °F (default), press and hold the + and - temperature set point buttons together for approximately 3 seconds.

2. Select the desired mode by pushing MODE.

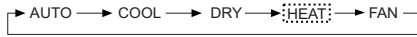

Fig. 9 —Modes

3. Select the temperature set point by pointing the control toward the unit and pressing the increase/decrease temperature set point buttons until the desired temperature appears on screen.
4. Press FAN to select the desired fan speed.

NOTE: If the unit is operating in DRY or AUTO mode, the fan speed will be automatically set and cannot be adjusted.

Set the airflow direction. When the unit is turned on, the Up-Down airflow louvers default to the cooling or heating position. The user can adjust the horizontal Up-Down airflow louver position by pushing DIRECT or have continuous louver movement by pressing SWING.

When the outside temperature is below 32°F (0°C), we strongly recommend maintaining power on the unit to ensure smooth ongoing performance.

To optimize unit performance, perform the following:

- Keep doors and windows closed
- Limit energy usage by using TIMER ON and TIMER OFF functions.
- Do not block air inlets or outlets.
- Regularly inspect and clean air filters.

Follow Me Function

The FOLLOW ME function enables the remote control to measure the temperature at its current location and send this signal to the air conditioner every 3 minutes interval. When using AUTO, COOL or HEAT modes, measuring ambient temperature from the remote control (instead of from the indoor unit itself) will enable the air conditioner to optimize the temperature around you and ensure maximum comfort.

NOTE: Press the SET button to select Follow Me function.

Pressing the OK button for 3 seconds will start/stop memory feature of Follow Me function.

- If the memory feature is activated, ON displays for 3 seconds on the screen
- If the memory feature is stopped, OFF displays for 3 seconds on the screen.
- While the memory feature is activated, press the ON/OFF button, shift the mode or power failure will not cancel the Follow me function.

FP Function

Press this button 2 times during one second under HEAT Mode and setting temperature of 60°F (16°C).

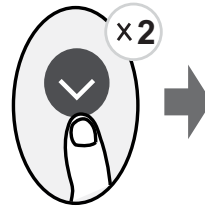

The unit will operate at high fan speed (while compressor on) with temperature automatically set to 46°F (8°C)

NOTE: This function is for heat pump air conditioner only.

Press this button 2 times under HEAT Mode and setting temperature of 60°F (16°C) to activate the FP function. Press On/Off, Mode, Fan and Temp. button or start sleep feature while operating will cancel this function.

NOTE: For a complete list of features of the remote control, refer to the Remote Controller, Owner's Manual.

GETTING TO KNOW YOUR AC

NOTE: Different models have different front panels and display windows. Not all the indicators described below are available for the air conditioner you purchased. Please check the indoor display window of the unit you purchased. Illustrations in this manual are for explanatory purposes. The actual shape of your indoor unit may differ.

Indoor Unit Display

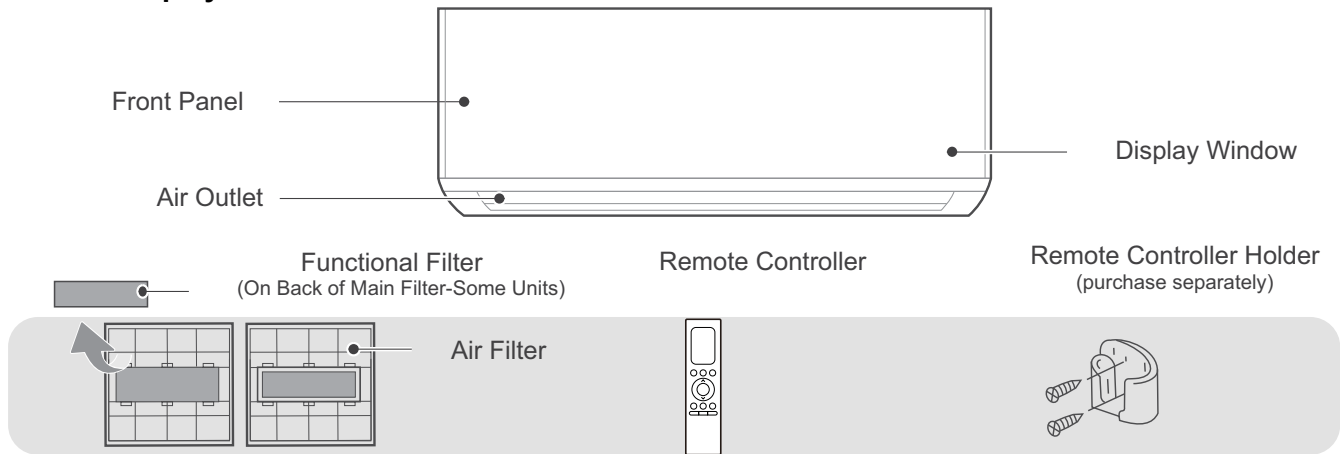

Display Windows	Display Code Meanings
	<ul style="list-style-type: none"> When Wireless Control feature is activated (For APP control units).
88	<ul style="list-style-type: none"> Displays temperature, operation feature and Error codes:
01 (for 3s when)	<ul style="list-style-type: none"> TIMER ON is set (if the unit is OFF, "01" remains on when TIMER ON is set). SWING, TURBO or SILENCE feature is turned on.
0F (for 3s when)	<ul style="list-style-type: none"> TIMER OFF is set. SWING, TURBO or SILENCE feature is turned off.
dF	<ul style="list-style-type: none"> When defrosting.
CL	<ul style="list-style-type: none"> When Active Clean feature is turned on.
FP	<ul style="list-style-type: none"> When 46°F(8°C) heating feature is turned on.

ADDITIONAL FEATURES

NOTE: Every time the air conditioner is powered on, the unit emits a buzzing sound to indicate that the product has been powered on normally. If there is no sound, it is possible that the unit has malfunctioned. Power on again or check the circuit. The actual functions are subject to the product you purchased, please check the indoor display and remote control of your unit. Review the Remote Controller Manual for more features.

Active Clean Function

The Active Clean Technology washes away dust when it adheres to the heat exchanger by automatically freezing and then rapidly thawing the frost. The Active Clean operation is used to produce more condensed water to improve the cleaning effect, and the cold air blows out. After cleaning, the internal wind wheel then keeps operating with hot air to blow-dry the evaporator, thus keeping the inside clean. When this function is turned on, the indoor unit display window appears “CL”, after 20 to 45 minutes, the unit turns off automatically and cancel the Active Clean function.

Auto-Restart

If the unit loses power, the unit automatically restarts with the prior settings once power has been restored.

Louver Angle Memory

When turning on your unit, the louver resumes its former angle.

Breeze Away

This feature avoids direct air flow blowing on the body.

Wireless Control (For App control units)

Wireless control allows you to control the air conditioner with a smart phone and a wireless connection. For the USB device access, replacement, maintenance operations must be carried out by professional staff.

Heat exchanger dust removal function

This feature helps keep the outdoor coil cleaner and may extend the duration between regular maintenance intervals depending on local conditions. When the unit is turned off, a 10 second delay occurs then the outdoor fan runs in reverse rotation for 70 seconds to blow off loose accumulated dust and debris.

Sleep Operation

Use **SLEEP** to decrease energy use while you sleep.

Press **SLEEP** on the remote control when in the **COOL** mode, the unit increases the temperature by 2°F (1°C) after 1 hour, and increases an additional 2°F (1°C) after another hour. When in **HEAT** mode, the unit decrease the temperature by 2°F (1°C) after 1 hour, and decreases an additional 2°F (1°C) after another hour. **SLEEP** stops after 8 hours and the system continues to run at the last setting.

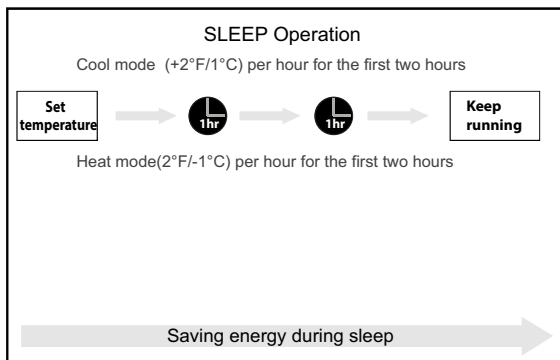

Fig. 10 — SLEEP Operation

Outdoor Unit Reverse Fan Operation function

This feature helps keep the outdoor coil cleaner and may extend the duration between regular maintenance intervals depending on local conditions. When the unit is turned off, a 10 second delay occurs then the outdoor fan runs in reverse rotation for 70 seconds to blow off loose accumulated dust and debris.

SETTING ANGLE OF AIR FLOW

- Do not set louver at too vertical an angle for long periods of time. When using COOL or DRY mode, water could condense on the louver blade and drop on your floor or furnishings.
- Setting vertical angle of air flow (remote control). While the unit is on, use SWING to set the direction (vertical/horizontal angle) of airflow. Refer to the Remote Control Manual for details.
- Setting the louver at too small an angle when using COOL or HEAT mode, can reduce the AC performance due to restricted air flow.

NOTE: Do not adjust the louver by hand. In order to reset the louver, turn off the unit and unplug it for a few seconds to restart.

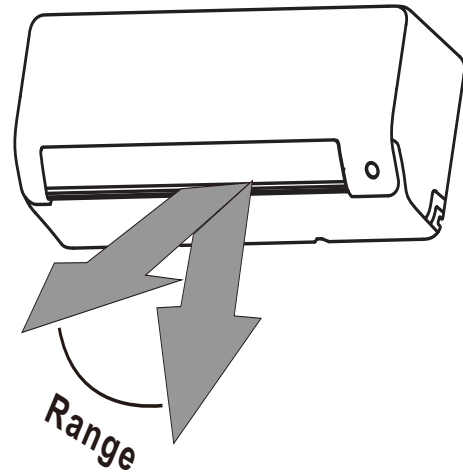

Fig. 11 — Louver Positions

Setting horizontal angle of air flow (Manual operation)

The horizontal angle of the airflow must be set manually. Grip the deflector rod and manually adjust it to your preferred direction. The horizontal angle of the airflow can be set by remote control. Please refer to the Remote Control Manual.

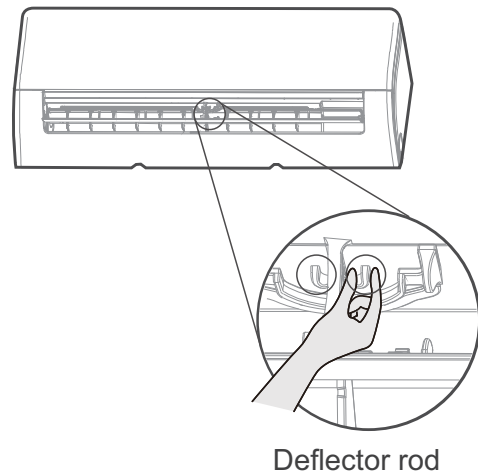

Fig. 12 — Deflector Rod

CARE AND MAINTENANCE

⚠ CAUTION

Do not place your fingers in or near the blower and suction side of the unit. The high-speed fan inside the unit may cause injury.

To Manually Operate the Unit

⚠ CAUTION

The manual button is intended for testing purposes and emergency operation only. Please do not use this function unless the remote control is lost and it is absolutely necessary. To restore regular operation, use the remote control to activate the unit. Unit must be turned off before manual operation.

1. Open the front panel of the indoor unit.
2. Locate **MANUAL CONTROL** on the right-hand side of the unit.
3. Press **MANUAL CONTROL** one time to activate **FORCED AUTO** mode.
4. Press **MANUAL CONTROL** again to activate **FORCED COOLING** mode.
5. Press **MANUAL CONTROL** a third time to turn the unit off.
6. Close the front panel.

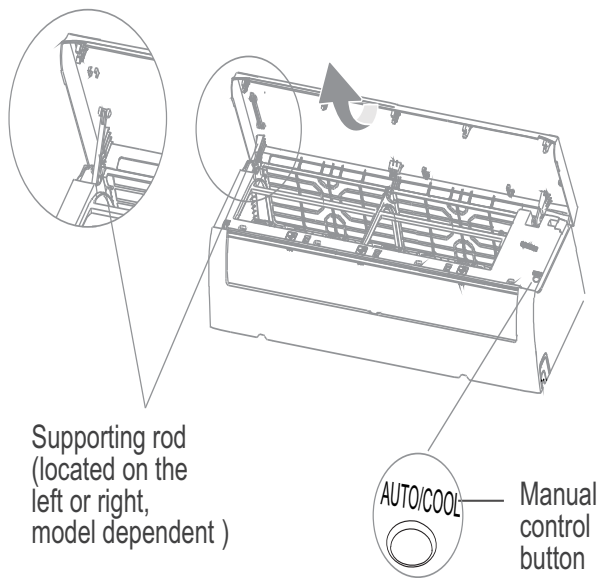

Fig. 13 — Manual Control Button

⚠ WARNING

The cooling efficiency of your unit and your health would be damaged for the clogged AC. Make sure to clean the filter every two weeks.

Always turn off your AC system and disconnect its power supply before cleaning or maintaining.

Do not touch the air freshening (Plasma) filter for at least 10 minutes after turning off the unit.

Only use a soft, dry cloth to wipe the unit clean. You can use a cloth soaked in warm water to wipe it clean if the unit is especially dirty.

Do not use chemicals or chemically treated cloths to clean the unit

Do not use benzene, paint thinner, polishing powder or other solvents to clean the unit. They can cause the plastic surface to crack or deform.

Do not use water hotter than 104°F(40°C) to clean the front panel. This can cause the panel to deform or become discolored.

Cleaning Your Indoor Unit, Air Filter

1. Lift the front panel of the indoor unit. For the unit with supporting rod, please use it to prop up the front panel.

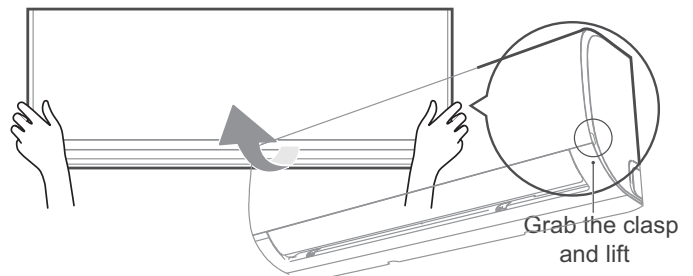

Fig. 14 — Lift Front Panel

2. Grip the tab on the end of the filter, lift it up, then pull it towards yourself and pull the filter out.

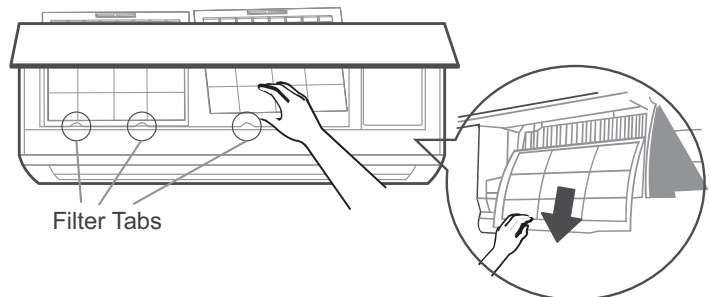

Fig. 15 — Pull Tabs Out

- If your filter has a small air freshening filter, unclip it from the larger filter. Clean this air freshening filter with a hand-held vacuum.

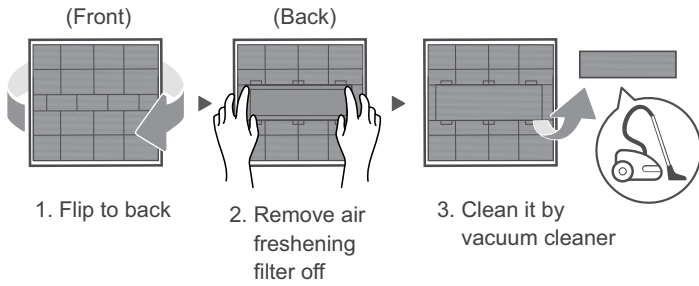
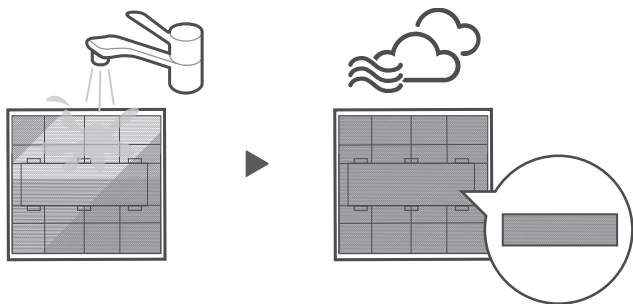

Fig. 16 — Clean Filter

- Clean the large air filter with warm, soapy water. Be sure to use a mild detergent. Rinse the filter with fresh water, then shake off any excess water. Dry it in a cool, dry place, and refrain from exposing it to direct sunlight.



Don't forget to install back

Fig. 17 — Clean Air Filter And Replace

- When dry, re-clip the air freshening filter to the larger filter, then install the air filter back on the top of the indoor unit.



Fig. 18 — Re-clip the Filter

⚠ CAUTION

Before changing the filter or cleaning, turn off the unit and disconnect its power supply.

When removing the filter, refrain from touching the metal parts in the unit. The sharp metal edges can injure you.

Do not use water to clean the inside of the indoor unit. This can destroy insulation and an cause electrical shock.

Do not expose filter to direct sunlight when drying. This can shrink the filter.

Any maintenance and cleaning of outdoor unit should be performed by an authorized dealer or a licensed service provider.

Any unit repairs should be performed by an authorized dealer or a licensed service provider.

Maintenance - Long Periods of Non-Use

If you plan not to use your air conditioner for an extended period of time, do the following:

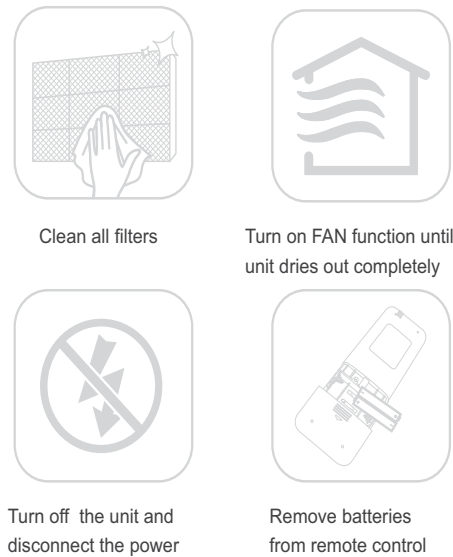

Fig. 19 — Long Periods of Non-Use

Maintenance - Pre-Season Use

After long periods of non-use, or before periods of frequent use, do the following:



Fig. 20 — Pre-Season Use

TROUBLESHOOTING



CAUTION

If any of the following conditions occurs, turn off your unit immediately.

- **The field wiring cable is damaged or abnormally warm**
- **You smell a burning odor**
- **The unit emits loud or abnormal sounds**
- **A power fuse blows or the circuit breaker frequently trips**
- **Water or other objects fall into or out of the unit**

DO NOT ATTEMPT TO FIX THESE YOURSELF. CONTACT AN AUTHORIZED SERVICE PROVIDER IMMEDIATELY.

Table 2 — Common Issues

Issue	Possible Causes
Unit does not turn on when pressing ON/OFF button	The Unit has a 3-minutes protection feature that prevents the unit from overloading. The unit cannot be restarted within three minutes of being turned off.
The unit changes from COOL/HEAT mode to FAN mode	The unit may change its setting to prevent frost from forming on the unit. Once the temperature increases, the unit will start operating in the previously selected mode again.
	The set temperature has been reached, at which point the unit turns off the compressor. The unit will continue operating when the temperature fluctuates again.
The indoor unit emits white mist	In humid regions, a large temperature difference between the room's air and the conditioned air can cause white mist.
Both the indoor and outdoor units emit white mist	When the unit restarts in HEAT mode after defrosting, white mist may be emitted due to moisture generated from the defrosting process.
The indoor unit makes noises	A rushing air sound may occur when the louver resets its position.
	A squeaking sound may occur after running the unit in HEAT mode due to expansion and contraction of the unit's plastic parts.
Both the indoor unit and outdoor unit make noises	Low hissing sound during operation: This is normal and is caused by refrigerant gas flowing through both indoor and outdoor units.
	Low hissing sound when the system starts, has just stopped running, or is defrosting: This noise is normal and is caused by the refrigerant gas stopping or changing direction.
	Squeaking sound: Normal expansion and contraction of plastic and metal parts caused by temperature changes during operation can cause squeaking noises.
The outdoor unit makes noises	The unit will make different sounds based on its current operating mode.
Dust is emitted from either the indoor or outdoor unit	The unit may accumulate dust during extended periods of non-use, which will be emitted when the unit is turned on. This can be mitigated by covering the unit during long periods of inactivity.
The unit emits a bad odor	The unit may absorb odors from the environment (such as furniture, cooking, cigarettes, etc.) which will be emitted during operations.
	The unit's filters have become moldy and should be cleaned.
The fan of the outdoor unit does not operate	During operation, the fan speed is controlled to optimize product operation.

NOTE: If problem persists, contact a local dealer or your nearest customer service center. Provide them with a detailed description of the unit malfunction as well as your model number.

Table 3 — Other Issues

When troubles occur, check the following points before contacting a repair company.

Problem	Possible Causes	Solution
Poor Cooling Performance	Temperature setting may be higher than ambient room temperature	Lower the temperature setting
	The heat exchanger on the indoor or outdoor unit is dirty	Use Clean function by remote control to clean the affected heat exchanger
	The air filter is dirty	Remove the filter and clean it according to instructions
	The air inlet or outlet of either unit is blocked	Turn the unit o, remove the obstruction and turn it back on
	Doors and windows are open	Make sure that all doors and windows are closed while operating the unit
	Excessive heat is generated by sunlight	Close windows and curtains during periods of high heat or bright sunshine
	Too many sources of heat in the room (people, computers, electronics, etc.)	Reduce amount of heat sources
	Low refrigerant due to leak or long-term use	Check for leaks, re-seal if necessary and top o refrigerant
	SILENCE function is activated (optional function)	SILENCE function can lower product performance by reducing operating frequency. Turn off SILENCE function
The unit is not working	Power failure	Wait for the power to be restored
	The power is turned off	Turn on the power
	The fuse is burned out	Replace the fuse
	Remote control batteries are dead	Replace batteries
	The Unit's 3-minutes protection has been activated	Wait three minutes after restarting the unit
	Timer is activated	Turn timer off
The unit starts and stops frequently	There is too much or too little refrigerant in the system	Check for leaks and recharge the system with refrigerant.
	Incompressible gas or moisture has entered the system.	Evacuate and recharge the system with refrigerant
	System circuit is blocked	Determine which circuit is blocked and replace the malfunctioning piece of equipment
	The compressor is broken	Replace the compressor
	The voltage is too high or too low	Install a manostat to regulate the voltage
Poor heating performance	The outdoor temperature is extremely low	Use auxiliary heating device
	Cold air is entering through doors and windows	Make sure that all doors and windows are closed during use
	Low refrigerant due to leak or long-term use	Call service center to check for leaks, re-seal if necessary and top off refrigerant
Indicator lamps continue flashing	The unit may stop operation or continue to run safely. If the indicator lamps continue to flash or error codes appear, wait for about 10 minutes. The problem may resolve itself. If not, disconnect the power, then connect it again. Turn the unit on. If the problem persists, disconnect the power and contact your nearest customer service center.	
Error code appears and begins with the letters as the following in the window display of indoor unit: E(x), P(x), F(x) EH(xx), EL(xx), EC(xx) PH(xx), PL(xx), PC(xx)		

NOTE: If the problem persists after performing checks and diagnostics above, turn off your unit immediately and contact an authorized service center.

ERROR CODES

Table 4 — Error Codes

DISPLAY	MALFUNCTION AND PROTECTION INDICATION
EC07	ODU fan speed out of control
EC0d	ODU malfunction
EC51	ODU EEPROM parameter error
EC52	ODU coil temp sensor error
EC53	ODU ambient temp sensor error
EC54	COMP. discharge temp sensor error
EC5b	IDU coil outlet temp sensor error
EH00	IDU EEPROM malfunction
EH03	IDU fan speed out of control
EH0A	IDU EEPROM parameter error
EH0b	IDU main control and display boards communication error
EH0E	Water-level alarm malfunction
EH3A	External fan DC bus voltage is too low protection
EH3b	External fan DC bus voltage is too high fault
EHb0	IDU room temp. sensor (T1) error
EHb1	IDU coil temp. sensor (T2) error
EHb2/ EHb6	Evaporator coil inlet temp. sensor (T2B) is in open circuit or short circuit
EHb5	Evaporator coil inlet temp. sensor (T2A) is in open circuit or short circuit
EHbA	Communication error between indoor unit and external fan module
EHb3	Communication malfunction between wire and master control
EL01	IDU & ODU communication error
EL0C	System lacks refrigerant
EL1b	Communication malfunction between adapter board and outdoor main board
FL09	Mismatch between the new and old platforms
PC00	ODU IPM module protection
PC01	ODU voltage protection
PC02	Compressor top (or IPM) temp. protection
PC03	Pressure protection (low or high pressure)
PC04	Inverter compressor drive error
PC0L	Low ambient temp. protection
----	IDUs mode conflict
<p>NOTE: The digital tube will show DF in defrost mode and FC in forced cooling mode. DF and FC are not error codes.</p>	